

FROST PROTECTION FOR GUTTERS AND DOWNPIPES

Melting and refreezing of ice can damage roofs and gutters. Heavy icicles may fall and cause injury. Standing water can leak through interior walls onto furnishings. The Raychem self-regulating snow melting system maintains water flow in gutters and drain pipes and provides a path whereby melting ice and snow can drain safely off the roof, along the gutter and down the drain pipe.

PRACTICAL TO INSTALL

The self-regulating cable can be closely spaced in gutters without the risk for overheating or burn-outs. There is a cable for each type of roof material.

ECONOMICAL TO OPERATE

The self-regulating effect saves energy by automatically increasing its heat output in icy water and decreasing its output in dry air. The smart EMDR-10 control unit only switches the heating cable on when necessary: after the detection of both low temperature and moisture.

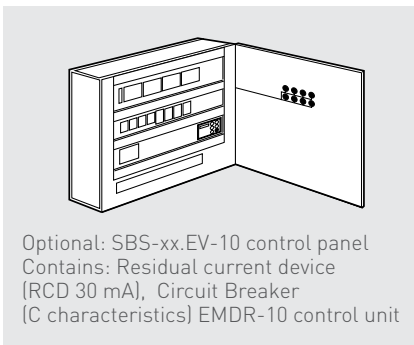

**Do not install RayClic immersed in water.
Do not bury RayClic in the ground.**

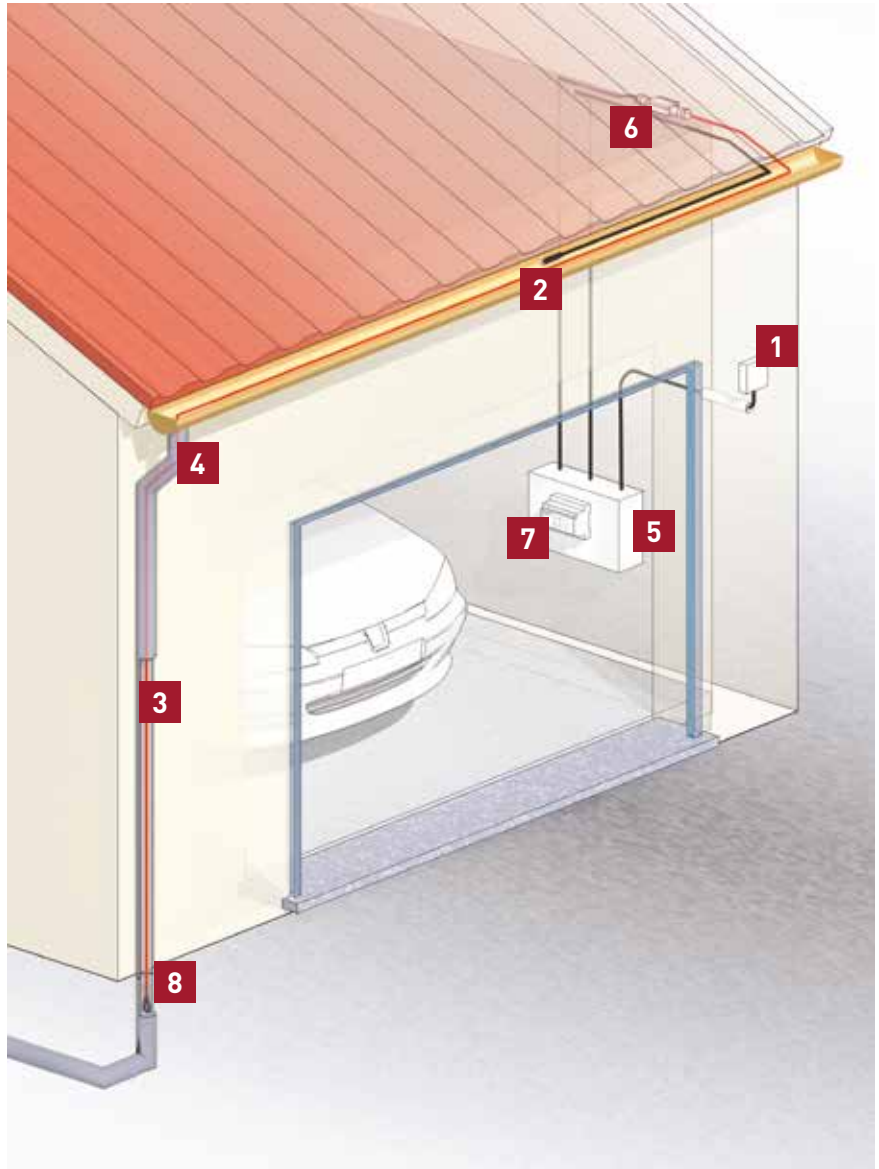

- | | |
|---|---|
| 1 Connection (RayClic-CE-02) | 5 Heating cable (GM-2X) |
| 2 Temperature sensor EMDR-10 (Incl.) | 6 Control unit (EMDR-10)  |
| 3 Moisture sensor EMDR-10 (Incl.) | 7 Residual current device (rcd 30 mA) Circuit-breaker (C type) |
| 4 Fixing bracket (GM-RAKE) | 8 End seal (RayClic-E-02) |

1 HEATING CABLE SELECTION

GM-2X, GM-2XT

Self-regulating heating cable for gutters, drain pipes and roof surfaces:
 • 36 W/m in iced water and 18 W/m in air at 0°C

2 COMPOSITION OF THE FS-A/B/C/C10-2X HEATING CABLE

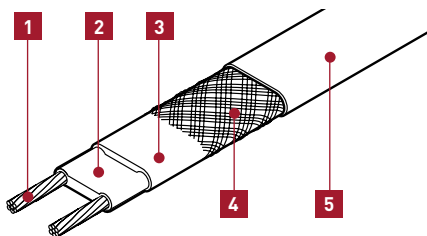

- 1 Copper conductor (1.2 mm²)
- 2 Self-regulating heating element
- 3 Insulation made of modified polyolefin
- 4 Tinned copper braid
- 5 Protective jacket (UV-resistant)

Important note: When laying cables on asphalt, bitumen, roofing felt, etc., a cable with a special fluoropolymer jacket (8BTV- 2-CT) must be used.

Technical data: see page 61

3 CABLE LENGTH

- The heating cable should be installed in a straight line in the gutter
- The cable lengths should be adjusted according to the geographical situation and the gutters
- More than one cable should be laid in wide valley, parapet or box gutters

Gutter length
 + drainpipe length
 + 1 m per connection
 + 1 m in the soil (frost line)
 = required heating cable length

4 ELECTRICAL PROTECTION

- The length of heating cable determines the number and size of the circuit breakers
- Residual current device (rcd): 30 mA required, max. 500 m heating cable per rcd
- Installation according to local regulations
- The power connections must be carried out by an approved electrical installer
- Use C type circuit-breakers

Max. length of the heating circuit is based on a minimum switch-on temperature of -10°C, 230 VAC.

	GM-2X, GM-2XT
6A	25 m
10 A	40 m
13 A	50 m
16 A	60 m
20 A	80 m

5 TESTING OF THE INSTALLATION See page 58

FROST PROTECTION FOR GUTTERS AND DOWNPIPES

6 CONTROL UNITS

EMDR-10

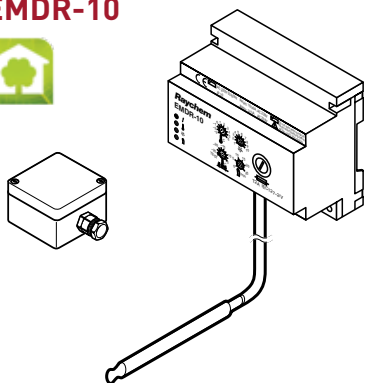

Smart control unit

- With temperature and moisture sensor
- User-friendly control
- Saves up to 80% energy
- Max. switching capacity 10 A (otherwise switching by contactor)
- Potential free alarm for sensor break age, sensor short and power loss

Technical data: see page 44

HTS-D

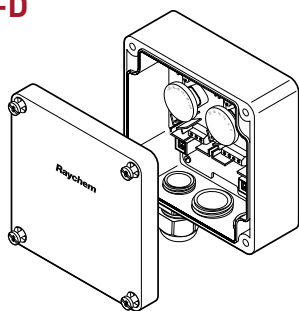

Standard thermostat

- 2 independent switching points
- Max. switching current: 16 A - 250 VAC
- Temperature adjustment range: -20°C to +25°C
- Outdoor installation
- Economical for circuit lengths up to 30 m

Technical data: see page 46

7 ACCESSORIES FOR GM-2X/GM-2XT

RayClic-CE-02

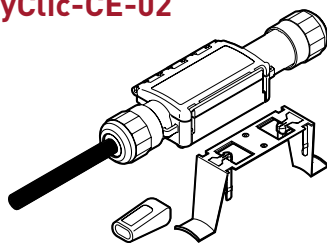

Power connection

- With 1.5 m power cable
- End seal and support bracket
- IP 68
- External dimension: L = 240 mm
W = 64 mm
H = 47 mm

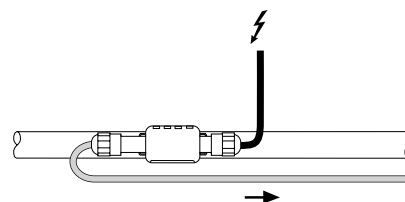

RayClic-T-02

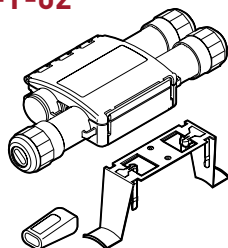

T-connection

- Connection for 3 cables
- 1 end seal and 1 support bracket
- IP 68
- External dimension: L = 270 mm
W = 105 mm
H = 42 mm

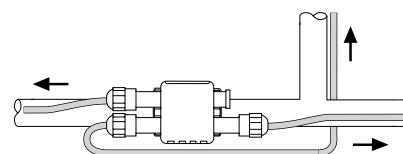

RayClic-PT-02

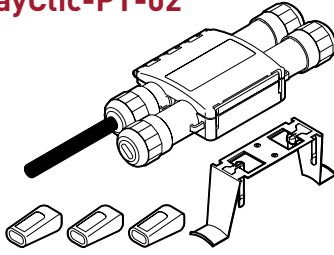

Power T-connection

- Connection for 3 cables with integral 1.5 m power cable
- 3 end seals and 1 support bracket
- IP 68
- External dimension: L = 270 mm
W = 105 mm
H = 42mm

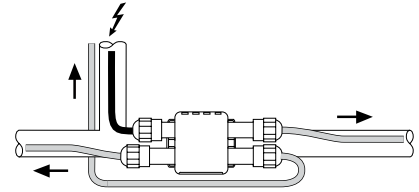

RayClic-PS-02

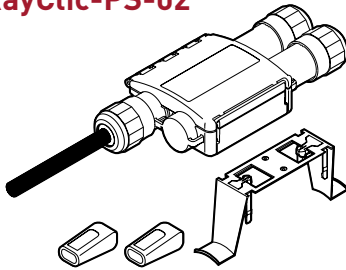

Powered splice

- Connection for 2 cables with integral 1.5 m power cable
- 2 end seals and 1 support bracket
- IP 68
- External dimension: L = 270 mm
W = 105 mm
H = 42 m

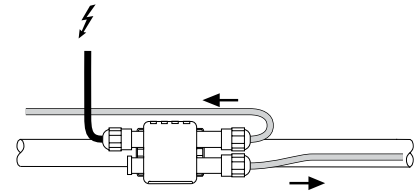

RayClic-E-02

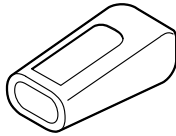

Gel-filled end seal

- For system extensions (to be ordered separately)
- IP 68



RayClic-SB-02

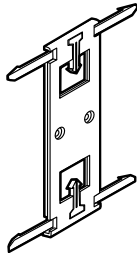

Wall-mounted support bracket

GM-RAKE

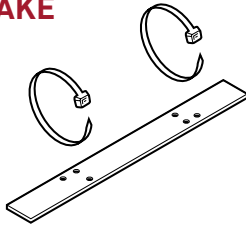

- Fixing bracket/edge protection for drainpipes
- Spacer for use in wide channels or gutters where more than one run of cable is required (a spacer is placed every 100 cm)
- VA steel with UV-resistant cable ties

IceStop-GMK-RC

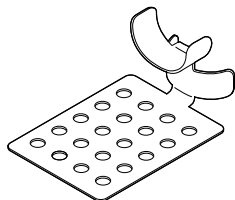

Roof clip to secure heating cables to roofs and gutters.

Adhesive can be applied on the underside of the roof clip. After curing of the adhesive the heating cable can be clipped between the clamps.

FROST PROTECTION FOR GUTTERS AND DOWNPIPES

GM-SEAL-02

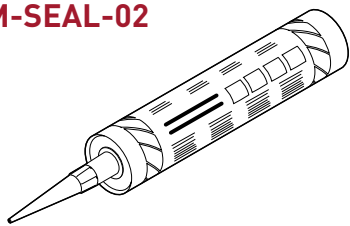

Adhesive for sticking and sealing common construction materials with a base of polyurethane perfectly suitable for metal or plastic gutters, roofing tiles and even asphalt and bitumen surfaces.

- 300 ml pack

CCE-03-CR (for GM-2X only)

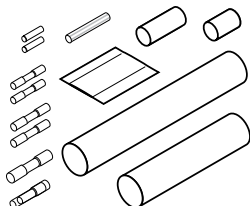

Cold lead connection and end seal kit

- Connection of 3 x 1.5 mm² or 3 x 2.5 mm² cold lead cable to self-regulating heating cable GM-2X

CCE-04-CT (for GM-2XT only)

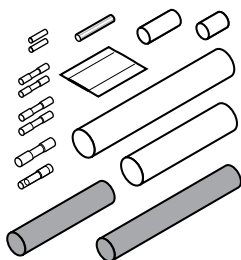

Cold lead connection and end seal kit

- Connection of 3 x 1.5 mm² or 3 x 2.5 mm² cold lead cable to self-regulating heating cables GM-2XT

8 GENERAL INSTALLATION INSTRUCTIONS

Installation of self-regulating heating cables

- Store in a dry and clean place.
- Temperature range: -40°C to +60°C.
- Protect any cable ends with an end seal.

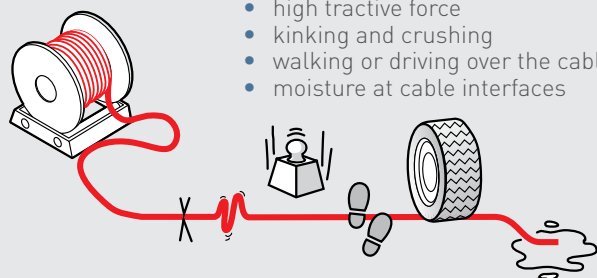

Avoid:

- sharp edges
- high tractive force
- kinking and crushing
- walking or driving over the cable
- moisture at cable interfaces

9 CONTROL PANEL

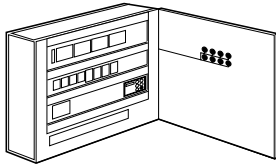

Steel plate housing, wall-mounted version, equipped with mains isolator, RCD/CB combination(s), indicators for 'Operation and Fault', inlet and outlet terminals. Completely assembled, wired and inspected. Cable guides in base of housing. An EMDR-10 control unit is installed in each switch cabinet.

Technical data: see page 47

SBS-03-EV-10

Control panel up to 3 heating circuits

- PCN: 295014-000

SBS-06-EV-10

Control panel up to 6 heating circuits

- PCN: 458484-000

SBS-09-EV-10

Control panel up to 9 heating circuits

- PCN: 206336-000

SBS-12-EV-10

Control panel up to 12 heating circuits

- PCN: 282458-000

10 CONTROL UNIT

EMDR-10

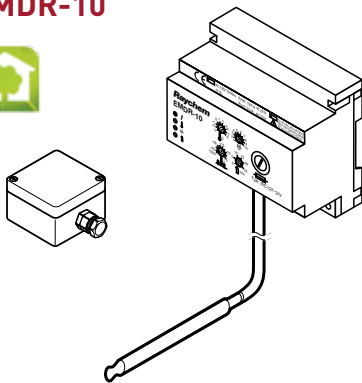

- With temperature and humidity sensor
- Saves up to 80% energy
- Max. permitted switching current 10 A (otherwise switch via power contactor)
- Alarm relay contact for sensor break, sensor short circuit and power failure.
- PCN: 449554-000

Technical data: see page 46.

HTS-D

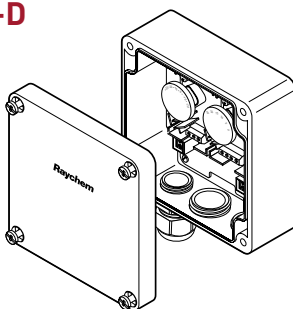

Thermostat

- Two independently adjustable switching points
- Max. permitted switching current 16 A - AC 250 V
- Adjustment range -20°C to +25°C
- Assembly in external area
- PCN: C71431-007

Technical data: see page 48.

FROST PROTECTION FOR GUTTERS AND DOWNPIPES

11 SPECIAL INSTALLATION INSTRUCTIONS

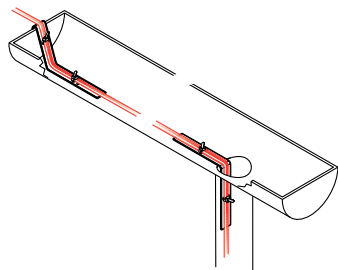

Box gutter < 200 mm

- One heating cable of GM-2X only

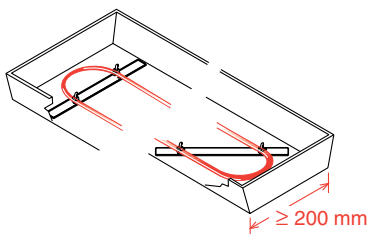

Box gutter > 200 mm

- Multiple heating cables of GM-2X
- 2 pc spacer GM-RAKE per meter of gutter edges: GM-RAKE provides mechanical protection against damages

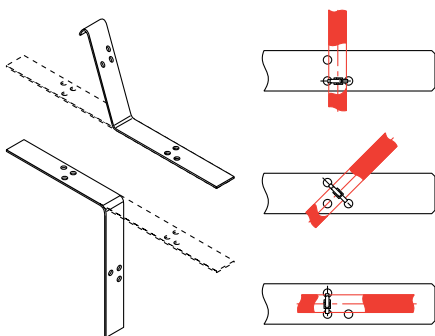

Fastening of the gutter cables

On the roof, eaves bricks, gutter and drainpipe with GM-RAKE edge protection brackets (incl. cable ties).



In the drainpipe: always install the cable as far as the frost-free area (approx. 1m deep)

**Do not install RayClic immersed in water.
Do not bury RayClic in the ground.**

TEMPERATURE AND MOISTURE CONTROL UNIT EMDR-10

TECHNICAL DATA

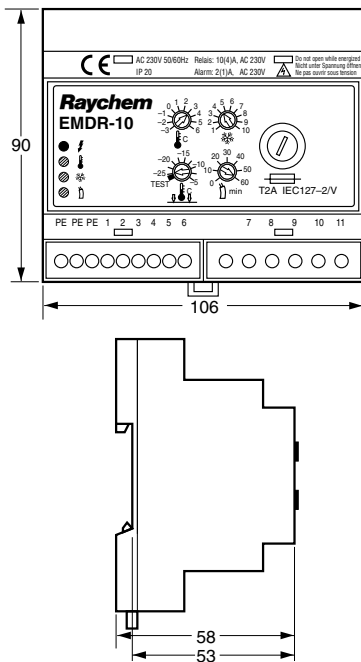

(Dimensions in mm)

Supply voltage	230 VAC, ±10%, 50Hz
Power consumption	max. 4 VA
Max. switching capacity	I _{max} 10(4)A / 230 VAC, SPST, potential 230 VAC
Temperature adjustment range	-3°C to +6°C (factory setting +2°C)
Lower limit temperature	test, -25°C to -5°C (factory setting adjustment range -15°C)
Operating differential	±0.5 K
Measuring accuracy	±1.5 K
Moisture adjustment range	1 (max. sensibility) to 10 (min. sensibility) (factory setting 5)
Post heating time adjustment range	0 to 60 minutes (factory setting 60 minutes)
Alarm relay	I _{max} 2(1)A / 230 VAC, SPDT, potential-free
Moisture sensor (output)	I _{max} 315mA / 230 VAC, with fuse 5 x 20mm T 315mA according to IEC127-2/V
Mounting	DIN rail according to DIN EN 50022-35
Low voltage directive	EN 60730
EMC	EN 50081-1 (emission) and EN 50082-1 (immunity)
Terminals	2.5 mm ² (stranded conductors), 4 mm ² (solid conductors)
Protection class	II (panel mounted)

HOUSING

Ambient temperature range	0°C to +50°C
Ingress protection	IP20
Housing material	Noryl (self-extinguishing according to UL 94 V-0)
Weight	approx. 350 g

AMBIENT TEMPERATURE SENSOR (VIA-DU-A10)

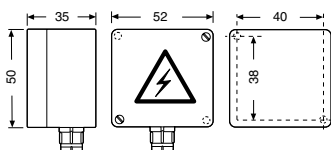

PG9 (Dimensions in mm)

Sensor type	PTC (FL 103)
Ingress protection	IP54
Terminals	2.5 mm ²
Sensor cable	2 x 1.5 mm ² , max. 100 m (not included)
Exposure temperature	-30°C to +80°C
Mounting	Wall mounting

MOISTURE SENSOR (HARD-45)

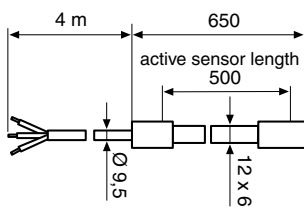

(Dimensions in mm)

Sensor type	PTC
Power consumption	9 W to 18 W
Ambient temperature range	-30°C to +65°C continuous
Supply voltage	230 VAC, ±10%, 50Hz
Connection cable	3 x 1.5 mm ² , 4 m, the connection cable can be extended to max. 100 m at 3 x 1.5 mm



EMDR-10 WITHOUT CONTACTOR

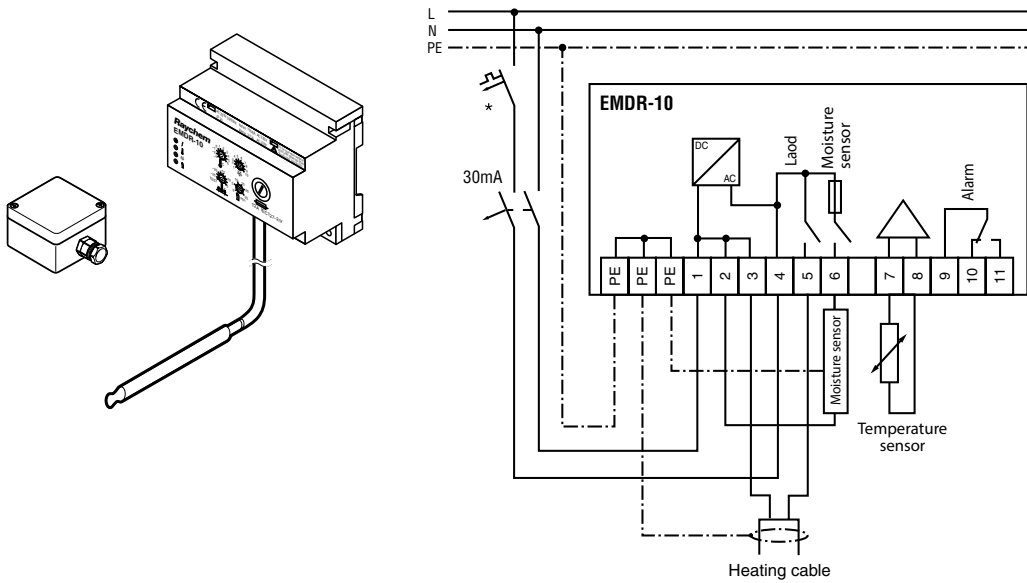

EMDR-10 WITH CONTACTOR

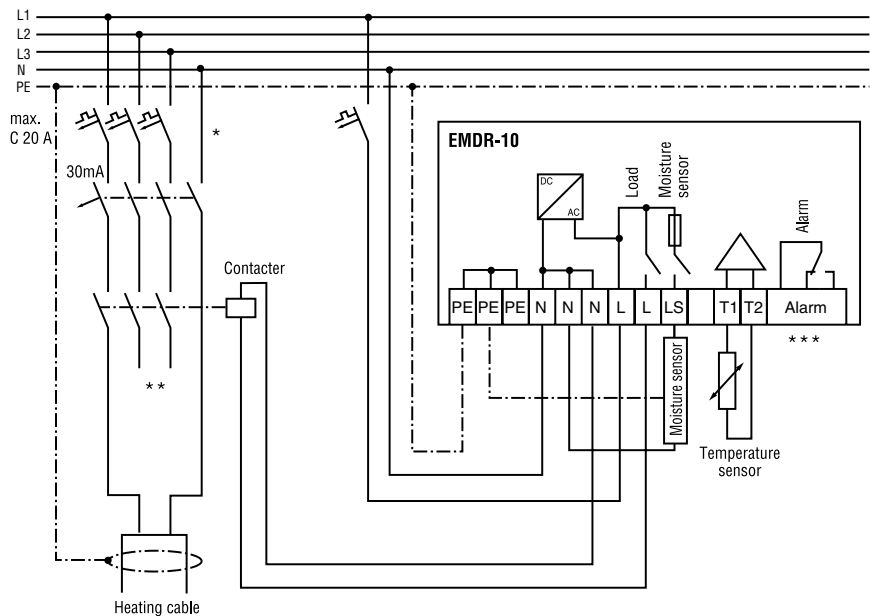

- * Two- or four-pole electrical protection by circuit breaker may be needed for local circumstances, standards and regulations
- ** Depending on the application, one or three-pole circuit breakers or contactors may be used
- *** Potential-free alarm contacts for connection to the BMS



TECHNICAL DATA

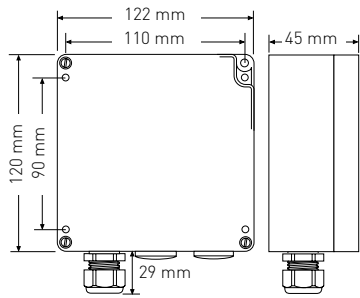

Temperature range	-20°C to +25°C
Operating voltage	AC 230 V, 50 Hz
Max. switch current	16 A / AC 250 V
Max. exposure temperature	50°C
Switch temperature difference	1 K - 3 K
Temperature setting	under the housing cover
Protective system	IP 65

WIRING DIAGRAM FOR HTS-D

HTS-D DIRECT

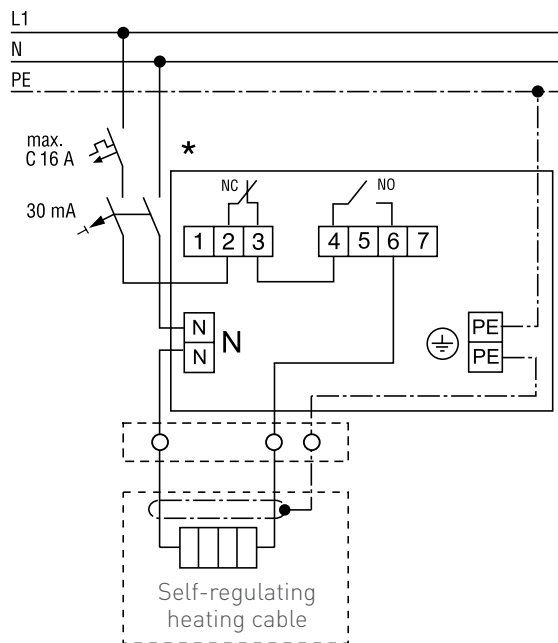
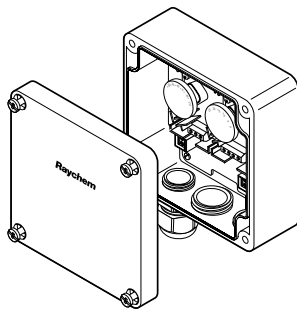

* Two- or four-pole electrical protection by circuit-breaker may be needed for local circumstances, standards and regulations

TECHNICAL DATA

Safety system for roof gutters

The standard control panels for 3, 6, 9 or 12 heating circuits comprise a steel plate housing and are completely assembled, in turnkey condition, wired and inspected.

Paintwork	Structural paint, RAL 7035, light gray
Protection class	IP54
Location	Interior
Ambient temperatures:	+5°C to +35°C
Cable inserts	Metal plate in base of housing with metric breakout apertures
Version	acc. to VDE 0660, Part 500 and VBG 4
Mains power connection	3-phase to 400V/230V, 50 Hz, with N and PE

Cabinet type			SBS-03-EV-10	SBS-06-EV-10	SBS-09-EV-10	SBS-12-EV-10
Max. number of heating circuits			3	6	9	12
Enclosure version			Wall version	Wall version	Wall version	Wall version
Dimensions	Width	mm	380	380	600	760
	Height	mm	600	600	600	760
	Depth	mm	210	210	210	210
Weight approx.		kg	20	30	32	52
Connected rating		kW	14	28	42	56
Fuse protection provided by customer	max.	A	3 x 32A NH-00	3 x 40A NH-00	3 x 63A NH-00	3 x 80A NH-00
Switch cabinet equipment						
Mains isolator switch, 3-pin, 32 A	Unit		1			
Mains isolator switch, 3-pin, 63 A	Unit			1	1	
Mains isolator switch, 3-pin, 100 A	Unit					1
Power isolator, S 2°	Unit		1	1	1	1
Combination of RCD/CB, C 20A, 30 mA, 4-pin with auxiliary switch	Unit		1	2	3	4
Power contactor, 3 x 35°	Unit		1	2	3	4
Auxiliary contactor	Unit		1	1	1	1
Indicator 'Operating'	Unit		1	2	3	4
Indicator 'Fault'	Unit		1	1	1	1
EMDR-10 control unit	Unit		1	1	1	1