

FROST PROTECTION FOR PIPES

Frozen pipes can be a costly problem. When pipes are exposed to sub-zero temperatures they can burst, leading to considerable damage and disruption. The Raychem frost protection system for pipes provides an efficient solution. The self-regulating heating cable, combined with an adequate insulation, prevents water pipes, fire mains, sprinkler systems and fuel oil lines from freezing.

EASY TO INSTALL

The heating cable is simply fixed onto the pipe – under the thermal insulation. Connections are quickly made with the fast RayClic connectors.

DURABLE AND RELIABLE

The cable's large copper conductors make it a reliable solution and its specially formulated outer jacket protects it from severe environmental conditions.

LOW POWER CONSUMPTION

The smart RAYSTAT -ECO control unit calculates a duty-cycle proportional to the expected minimum temperature. Where a simple ambient thermostat would energize the heating cable for 100%, the "smart" controller would energize for a fraction of the time, resulting in significant extra savings.

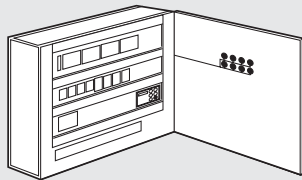

Optional: SBS-xx-SV control panel contains: RCD (30 mA), Circuit breaker (CB) [C characteristics] space available in switch cabinet for installation of a thermostat.

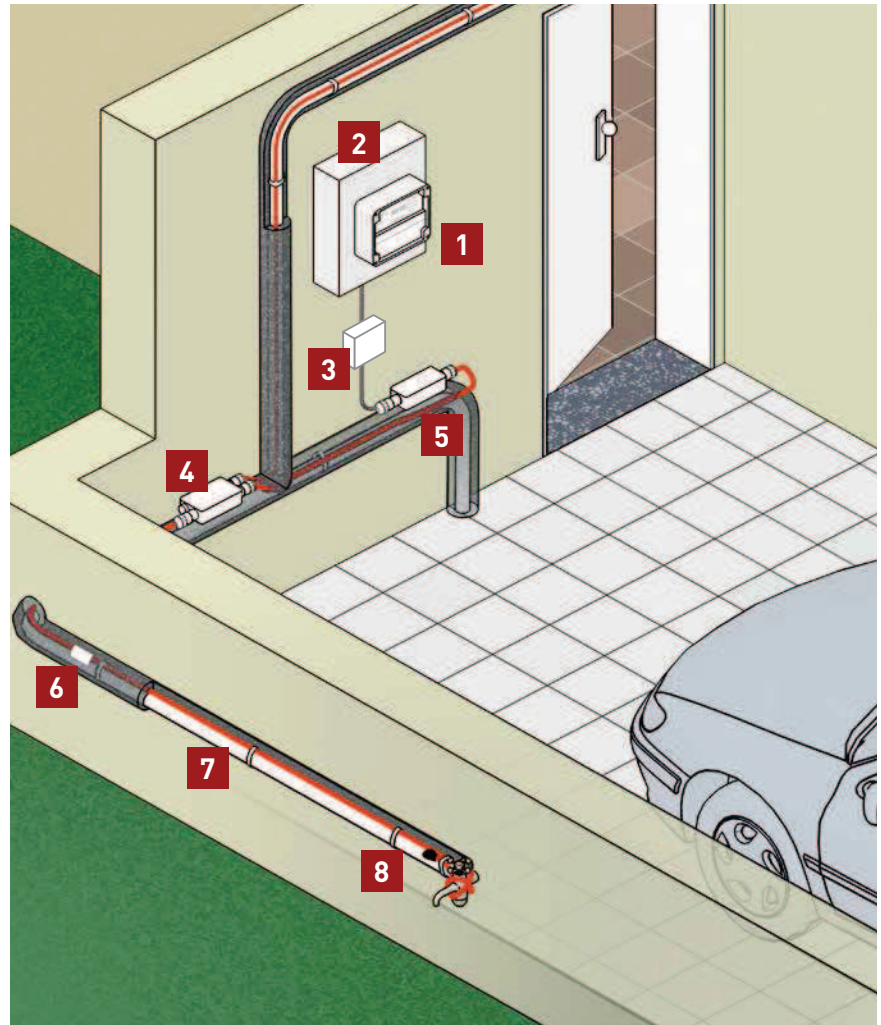

- | | | | |
|----------|---|----------|---|
| 1 | Thermostat with line or ambient temperature sensor | 5 | Power connection (RayClic-CE-02) (Not for FS-C-2X / FS-C10-2X) |
| 2 | Residual current device (30 mA) Circuit-breaker [C type] | 6 | Electrical traced label (LAB-I-01) |
| 3 | Junction box (JB16-02) | 7 | Frost protection heating cable (FS-A-2X, FS-B-2X, FS-C-2X or FS-C10-2X) |
| 4 | T-Connection (RayClic-T-02) (Not for FS-C-2X / FS-C10-2X) | 8 | End seal (RayClic-E-02) (Not for FS-C-2X / FS-C10-2X) |

1 HEATING CABLE SELECTION

Application	
Frost protection for pipework at max. 65°C operating temperature	
FS-A-2X	10 W/m at 5°C
FS-B-2X	26 W/m at 5°C
Frost protection for pipework at max. 95°C operating temperature and temperature maintenance for metal waste pipes with fatty waste water	
FS-C-2X	31 W/m at 5°C
	22 W/m at 40°C
Frost Protection for pipework to maximum 90°C operating temperature. For long circuit applications and central heating pipework.	
FS-C10-2X	10 W/m at 5°C

TraceCalc.Net Construction is a software tool for product selection based on actual project data. Visit www.thermal.pentair.com

2 COMPOSITION OF THE FS-A/B/C/C10-2X HEATING CABLE

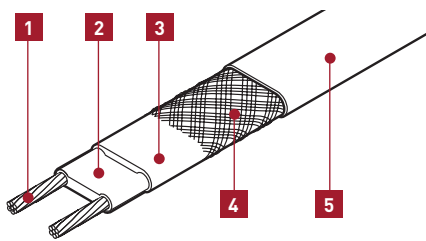

- 1 Copper conductor (1.2 mm²)
- 2 Self-regulating heating element
- 3 Modified polyolefin insulation (FS-C-2X: Fluoropolymer)
- 4 Protective tinned copper braid
- 5 Modified polyolefin protective outer jacket.

Note: FS-C10-2X comprises copper conductors (1.4 mm²)

3 HEATING CABLE LENGTH

Frost protection down to -20°C.

Insulation thicknesses	Pipe diameter												
	mm Inches	15 1/2"	22 3/4"	28 1"	35 5/4"	42 1 1/2"	54 2"	67 2 1/2"	76 3"	108 4"	125 5"	150 6"	200 8"
10 mm		FS-A-2X FS-C10-2X	FS-B-2X	FS-B-2X	FS-B-2X	FS-B-2X	FS-B-2X	FS-B-2X	FS-B-2X	FS-B-2X	FS-B-2X	FS-B-2X	FS-B-2X
15 mm		FS-A-2X FS-C10-2X	FS-A-2X FS-C10-2X	FS-A-2X FS-C10-2X	FS-B-2X	FS-B-2X	FS-B-2X	FS-B-2X	FS-B-2X	FS-B-2X	FS-B-2X	FS-B-2X	FS-B-2X
20 mm		FS-A-2X FS-C10-2X	FS-A-2X FS-C10-2X	FS-A-2X FS-C10-2X	FS-A-2X FS-C10-2X	FS-A-2X FS-C10-2X	FS-B-2X	FS-B-2X	FS-B-2X	FS-B-2X	FS-B-2X	FS-B-2X	FS-B-2X
25 mm		FS-A-2X FS-C10-2X	FS-A-2X FS-C10-2X	FS-A-2X FS-C10-2X	FS-A-2X FS-C10-2X	FS-A-2X FS-C10-2X	FS-A-2X FS-C10-2X	FS-B-2X	FS-B-2X	FS-B-2X	FS-B-2X	FS-B-2X	FS-B-2X
30 mm		FS-A-2X FS-C10-2X	FS-A-2X FS-C10-2X	FS-A-2X FS-C10-2X	FS-A-2X FS-C10-2X	FS-A-2X FS-C10-2X	FS-A-2X FS-C10-2X	FS-A-2X FS-C10-2X	FS-B-2X	FS-B-2X	FS-B-2X	FS-B-2X	FS-B-2X
40 mm		FS-A-2X FS-C10-2X	FS-A-2X FS-C10-2X	FS-A-2X FS-C10-2X	FS-A-2X FS-C10-2X	FS-A-2X FS-C10-2X	FS-A-2X FS-C10-2X	FS-A-2X FS-C10-2X	FS-A-2X FS-C10-2X	FS-B-2X	FS-B-2X	FS-B-2X	FS-B-2X
50 mm		FS-A-2X FS-C10-2X	FS-A-2X FS-C10-2X	FS-A-2X FS-C10-2X	FS-A-2X FS-C10-2X	FS-A-2X FS-C10-2X	FS-A-2X FS-C10-2X	FS-A-2X FS-C10-2X	FS-A-2X FS-C10-2X	FS-A-2X FS-C10-2X	FS-B-2X	FS-B-2X	FS-B-2X

Frost protection cables FS-A-2X, FS-B-2X and FS-C10-2X are suitable for any pipe material (copper, threaded pipes, stainless steel pipes, plastic pipes and composite metal pipes without restriction).

For plastic pipes, please use aluminium adhesive tape ATE-180. The frost protection cable should be covered along its entire length. Heat insulation $\lambda = 0.035 \text{ W/(m.K)}$ or better.

Important note: frost protection heating cables with fluoropolymer protective jacket (e.g. type BTV2-CT) must be used for solvent-containing, mixed and/or bitumen-coated heat insulation.

FROST PROTECTION FOR PIPES

40°C temperature maintenance on pipelines for fatty waste water

	Pipe diameter (mm)							
Insulation thicknesses	42	54	67	76	108	125	150	200
	1 1/2"	2"	2 1/2"	3"	4"	5"	6"	8"
30 mm	FS-C-2X							
40 mm	FS-C-2X	FS-C-2X	FS-C-2X					
50 mm	FS-C-2X	FS-C-2X	FS-C-2X	FS-C-2X				
60 mm	FS-C-2X	FS-C-2X	FS-C-2X	FS-C-2X	FS-C-2X	FS-C-2X	FS-C-2X	FS-C-2X

Min. ambient temperature -10°C. Heat insulation $\lambda = 0.035 \text{ W}/(\text{m}\cdot\text{K})$ or better.

Cable type FS-C-2X should only be used in conjunction with pipework with a minimum continuous temperature resistance of 90°C. A line-sensing control thermostat (type AT-TS-14, RAYSTAT-CONTROL-10 or RAYSTAT-CONTROL-11-DIN) must be used on plastic pipework (setting approx. 40°C).

4 CABLE LENGTH

The heating cable should be installed in a straight line on the pipework. Cable loops instead of T-connections can be made on short dead legs.

(up to approx. 3 m)

+ approx. 0.3 m per connection

+ approx. 1.0 m per T-connection

+ approx. 1.2 m per 4-way connection

Additional cable required for increased heat sinks at valves from 2" and for uninsulated pipe supports (approx. 1 m)

= required heating cable length

5 ELECTRICAL PROTECTION

- The total length of heating cable determines the number and size of the fuses
- Residual current device (rcd) : 30 mA required, max. 500 m heating cable per rcd
- Installation according to local regulations
- The power connections must be carried out by an approved electrical installer
- Use C type circuit-breakers

Max. length of the heating circuit is based on a minimum switch-on temperature of 0°C, 230 VAC.

	FS-A-2X	FS-B-2X	FS-C-2X	FS-C10-2X
4 A	45 m	25 m	20 m	45 m
6 A	70 m	35 m	30 m	70 m
10 A	110 m	65 m	55 m	110 m
13 A	130 m	85 m	70 m	130 m
16 A	150 m	105 m	90 m	150 m
20 A	-	-	-	180 m

Note: A splice can also be made using an S-06

6 TESTING OF THE INSTALLATION See page 58

7 CONTROL PANELS

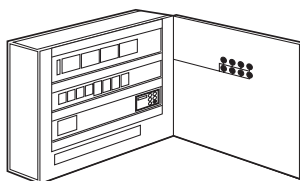

Steel plate housing, wall-mounted version, equipped with mains isolator, RCD/CB combination(s), power contactor(s), indicators for 'Operation and Fault', operating mode selector switch, inlet and outlet terminals. Completely assembled, turnkey condition, wired and inspected. wiring schematics in panel housing. An installation slot is provided for a RAYSTAT-CONTROL-11-DIN, RAYSTAT-CONTROL-10 and/or RAYSTAT-ECO-10 thermostat, each serving 3 heating circuits. Factory fitted. Please contact us for more information.

Technical data: See page 25.

SBS-03-SV**Switch cabinet for 1 to 3 heating circuits.**

- PCN: 355825-000
-

SBS-06-SV**Control Panel for 4 to 6 heating circuits.**

- PCN: 778308-000
-

SBS-09-SV**Control Panel for 7 to 9 heating circuits.**

- PCN: 767989-000
-

SBS-12-SV**Control panel for 10 to 12 heating circuits.**

- PCN: 1244-000025
-

For sprinkler systems

Steel plate housing, wall-mounted version, equipped with mains power switch, low-voltage (LV) relay, RCD/CB combination(s), buzzer, power contactor(s), auxiliary contactor(s), operating mode selector switch, Indicators for 'Operating and Fault', 'Mains power', inlet and outlet terminals. Completely assembled, wired and inspected. Wiring schematics included in housing 1 temperature controller is installed per heating circuit in the switch cabinet.

SBS-02-SNR**Control panel for 2 heating circuits (Inc. redundant).****SBS-04-SNR****Control panel for 4 heating circuits (Inc. redundant).****SBS-06-SNR****Control panel for 6 heating circuits (Inc. redundant).****SBS-08-SNR****Control Panel for 8 heating circuits (Inc. redundant).****SBS-10-SNR****Control panel for 10 heating circuits (Inc. redundant).****SBS-12-SNR****Control panel for 12 heating circuits (Inc. redundant).**

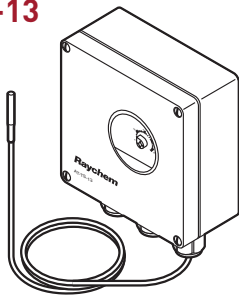
8 THERMOSTATS**AT-TS-13****Thermostat**

- Adjustable temperature range: -5°C to $+15^{\circ}\text{C}$
- Line-sensing control thermostat or ambient thermostat
- Max. switching current 16 A, 250 VAC

Technical data: see page 26

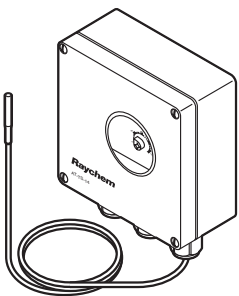
AT-TS-14**Thermostat**

- Adjustable temperature range: 0°C to 120°C
- Temperature maintenance on pipelines for fatty waste water
- Line-sensing control thermostat
- Max. switching current 16 A, 250 VAC

Technical data: see page 26

FROST PROTECTION FOR PIPES

RAYSTAT-ECO-10

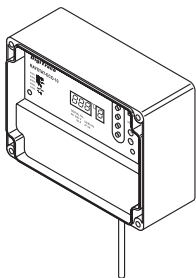

Ambient temperature thermostat

- Adjustable temperature range: 0°C to 30°C
- Max. switching current 25 A, 250 VAC
- PASC (Proportional Ambient Sensing Control) for energy saving
- Alarm relay: 2 A voltfree with indication of sensor errors, voltage errors and low or high temperature alarm
- Display for visual indication of parameters

Technical data: see page 28

RAYSTAT-CONTROL-10

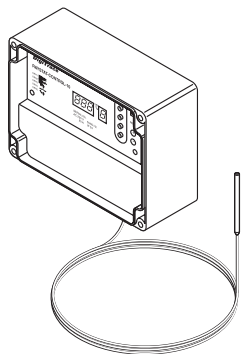

Line-sensing thermostat

- Adjustable temperature range: 0°C to 150°C
- Max. switching current 25 A, 250 VAC
- Alarm relay: 2 A voltfree with indication of sensor errors, voltage errors and low or high temperature alarm
- Display for visual indication of parameters

Technical data: see page 30

RAYSTAT-CONTROL-11-DIN

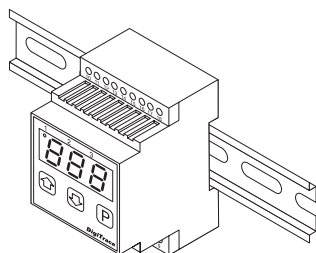

Line sensing thermostat with digital display for DIN rail mounting applications.

- Set temperature range: 0 - 65°C.
- Digital display of maintain temperature and alarm information. 16A switching.
- Low temperature alarm function
- DIN rail/Panel mountable control.
- Sensor type: PT100.

Technical data: see page 32

SB-100

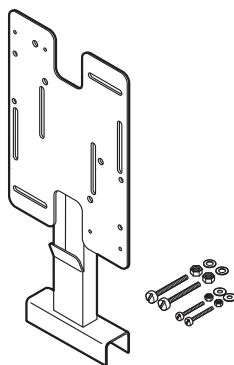

Stainless steel support bracket

- Specially constructed to provide heating cable protection between pipe and junction box via a tubular leg.
- For use with AT-TS-13, AT-TS-14, JB16-02 and RAYSTAT-CONTROL-10

SB-101

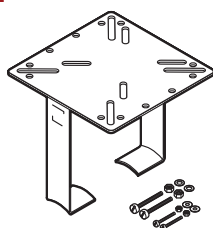

Dual-leg support bracket, stainless steel

- Height leg: 160 mm
- For use with AT-TS-13, AT-TS-14, JB16-02 and RAYSTAT-CONTROL-10

SB-110

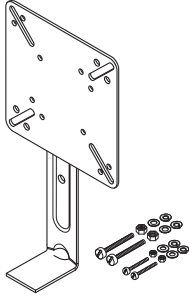

Support bracket, stainless steel

- Height leg: 100 mm
- For use with AT-TS-13, AT-TS-14, and JB16-02

SB-111

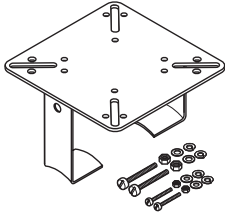

Support bracket, stainless steel

- Height leg: 100 mm
- For use with AT-TS-13, AT-TS-14, and JB16-02

9 ACCESSORIES FOR FS-A-2X AND FS-B-2X CABLES

	FS-A-2X / FS-B-2X
Power connection	RayClic-CE-02
Splice	RayClic-S-02
Powered splice	RayClic-PS-02
T-connection	RayClic-T-02
Powered T-connection	RayClic-PT-02
Four way connection	RayClic-X-02

Note: A splice can also be made using an S-06

RayClic-CE-02

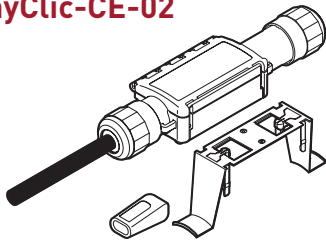

Power connection

- With 1.5 m power cable
- End seal and support bracket
- IP 68
- External dimension: L = 240 mm
W = 64 mm
H = 47 mm

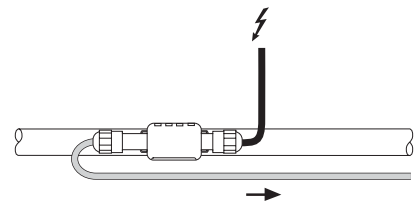

Note: RayClic components are not compatible with FS-C-2X /FS-C10-2X

RayClic-T-02

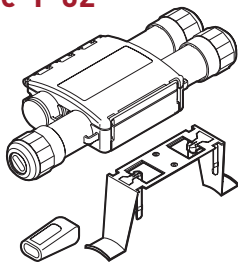

T-connection

- Connection for 3 cables
- End seal and support bracket
- IP 68
- External dimension: L = 270 mm
W = 105 mm
H = 42 mm

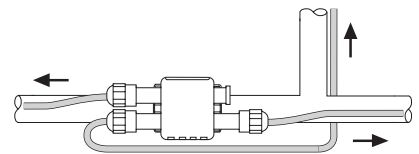

Note: RayClic components are not compatible with FS-C-2X /FS-C10-2X

RayClic-PT-02

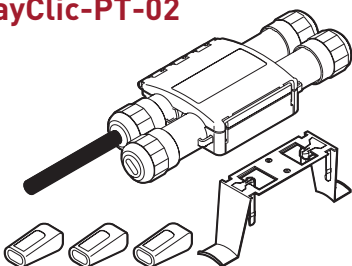

Power T-connection

- 3 connections with integral 1.5 m power cable
- 3 end seals and 1 support bracket
- IP 68
- External dimension: L = 270 mm
W = 105 mm
H = 42 mm

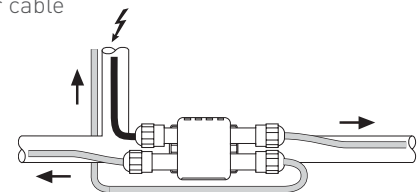

Note: RayClic components are not compatible with FS-C-2X /FS-C10-2X

FROST PROTECTION FOR PIPES

RayClic-S-02

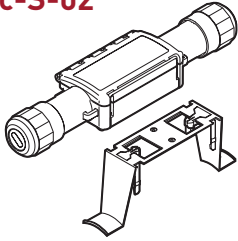

Splice for joining 2 lengths of heating cable

- Connection for 2 cables with 1 support bracket
- IP 68
- External dimension: L = 240 mm
W = 64 mm
H = 47 mm

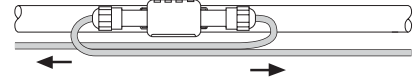

Note: RayClic components are not compatible with FS-C-2X /FS-C10-2X

RayClic-PS-02

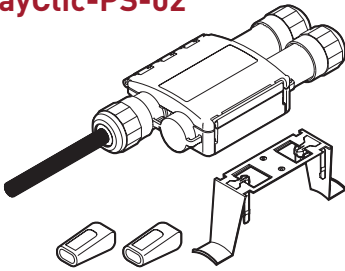

Powered splice

- Connection for 2 cables with integral 1.5 m power cable
- 2 end seals and 1 support bracket
- IP 68
- External dimension: L = 270 mm
W = 105 mm
H = 42 mm

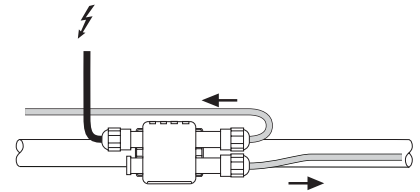

Note: RayClic components are not compatible with FS-C-2X /FS-C10-2X

RayClic-X-02

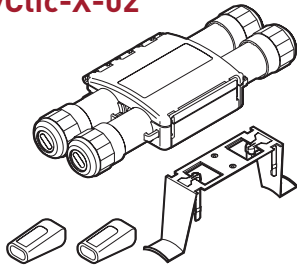

4-way connection

- Connection for 4 cables
- 2 end seals and 1 support bracket
- IP 68
- External dimension: L = 270 mm
W = 105 mm
H = 42 mm

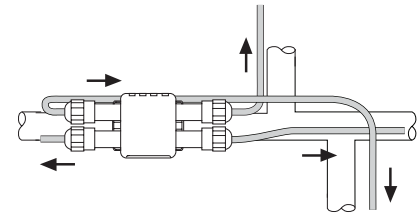

Note: RayClic components are not compatible with FS-C-2X /FS-C10-2X

RayClic-E-02

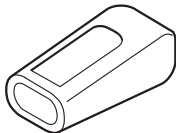

Gel-filled end seal

- For system extensions (to be ordered separately)
- IP 68



Note: RayClic components are not compatible with FS-C-2X /FS-C10-2X

10 ACCESSORIES FOR FS-C-2X, FS-C10-2X AND BTV-2-CT CABLES

		For BTV-2-CT		For FS-C-2X/ FS-C10-2X	
Power connection	1 JB16-02 +	1 C25-21 + 1 E-06	+	1 CE20-01	+ JB-SB-08
Splice	1 JB16-02 +	2 C25-21 + 1 E-06	+	2 CE20-01	+ JB-SB-08
Powered splice	1 JB16-02 +	2 C25-21 + 2 E-06	+	2 CE20-01	+ JB-SB-08
T-connection	1 JB16-02 +	3 C25-21 + 2 E-06	+	3 CE20-01	+ JB-SB-08
Powered T-connection	1 JB16-02 +	3 C25-21 + 3 E-06	+	3 CE20-01	+ JB-SB-08
Four way connection	1 JB16-02 +	4 C25-21 + 3 E-06	+	4 CE20-01	+ JB-SB-08

JB16-02

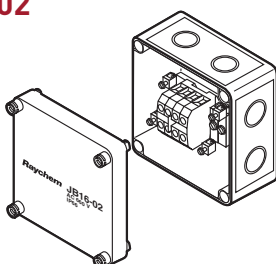

Temperature-resistant junction box

- For FS-C-2X, FS-C10-2X and BTV-2-CT
- For power connection or T-connection
- IP66
- 6 x 4 mm² terminals
- 4 Pg 11/16, 4 M20/25 knock-out entries

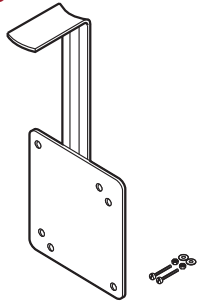
JB-SB-08**Single-leg support bracket**

- for junction and connection box JB16-02

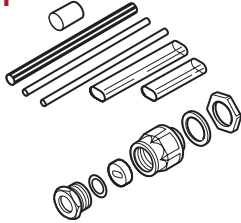
CE20-01**Connection and end seal kit for FS-C-2X/FS-C10-2X cables**

- Heat-shrink technique
- M20 gland

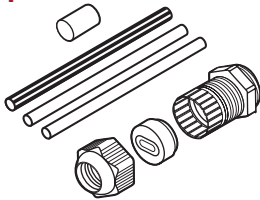
C25-21**Connection kit for BTV2-CT**

- Heat-shrink technique
- M25 gland

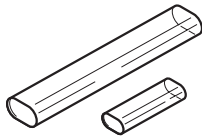
E-06**End seal kit for BTV2-CT**

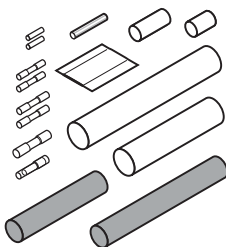
CCE-04-CT**Cold lead connection and end seal kit**

- Connection of 3 x 1.5 mm² or 3 x 2.5 mm² cold lead cable to self-regulating heating cables BTV-CT, FS-C -2X and FS-C10-2X.

11 GENERAL ACCESSORIES

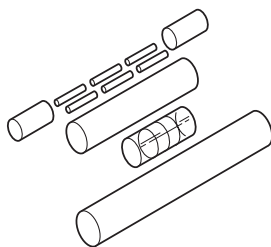
S-06**In-line splice kit**

- for FS-A-2X and FS-B-2X

FROST PROTECTION FOR PIPES

S-19

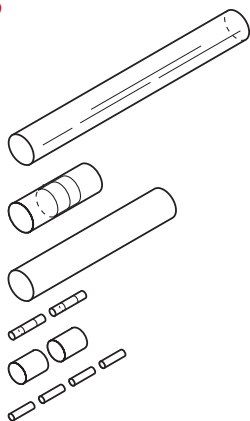

In-line splice kit

- for FS-C-2X , FS-C10-2X and BTV-2-CT

CCE-03-CR

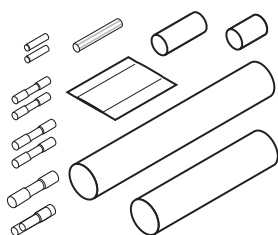

Cold lead connection and end seal kit

- Connection of 3 x 1.5 mm² or 3 x 2.5 mm² cold lead cable to self-regulating heating cables FS-A-2X and FS-B-2X

KBL-10

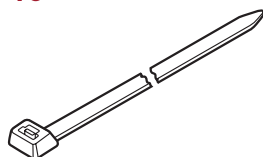

Cable ties

- One pack of 100 required for approx. 30 m of pipework
- Length: 370 mm
- Temperature and UV resistant

Use ATE-180 on plastic pipes

GT-66

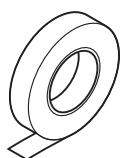

Heat-resistant glass cloth tape

- For steel pipes or for any installation below 4.4°C
- 20 m roll for approx. 20 m of pipework

Use ATE-180 on plastic pipes

GS-54



Glass cloth tape for attaching heating cable to pipe

- For stainless-steel pipes or for any installation below 4.4°C
- 16 m per roll, 12 mm width

ATE-180

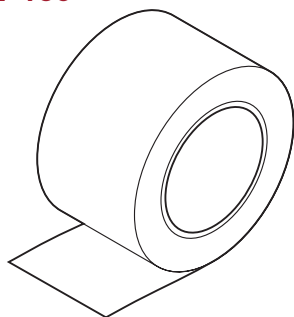

Aluminium adhesive tape

- Heat resistant
- 55 m roll for approx. 50 m of pipework

On plastic pipes: the heating cable must be covered with aluminium adhesive tape along its entire length

IEK-20-M

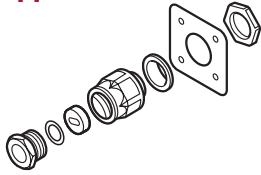

Insulation entry kit

- Insertion of heating cable in metal cladding
- Consists of: metal fastener, metric gland and joint seal

LAB-I-01



Electric traced label

- To be placed at 5 m intervals on insulation surface

12 GENERAL INSTALLATION INSTRUCTIONS See page 61

13 SPECIAL INSTALLATION INSTRUCTIONS

PLACING OF SENSOR

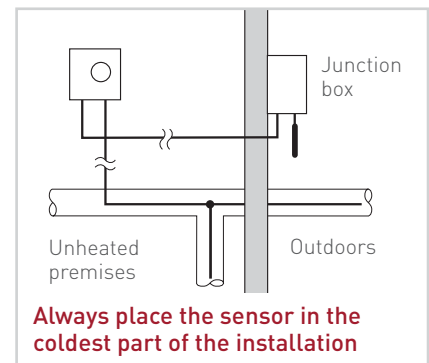
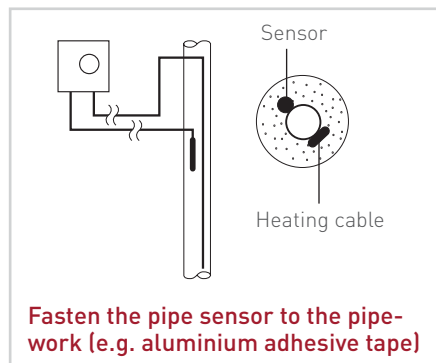
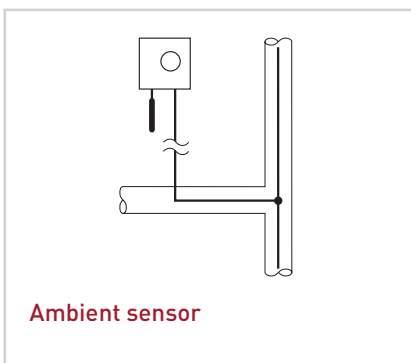

Cabinet type			SBS-03-SV	SBS-06-SV	SBS-09-SV	SBS-12-SV
Max. number of heating circuits			3	6	9	12
Enclosure version			Wall version	Wall version	Wall version	Wall version
Dimensions	Width	mm	380	600	760	760
	Height	mm	600	600	760	760
	Depth	mm	210	210	210	210
Weight	approx.	kg	20	30	50	52
Connected rating		kW	11	22	33	42
Customer fuse protection	max.	A	3 x 25A NH-00	3 x 32A NH-00	3 x 63A NH-00	3 x 80A NH-00
Switch cabinet equipment						
Mains isolator switch, 3-pin, 25 A	Unit		1			
Mains isolator switch, 3-pin, 32 A	Unit			1		
Mains isolator switch, 3-pin, 63 A	Unit				1	
Mains isolator switch, 3-pin, 100 A	Unit					1
Power isolator, S 2°	Unit		1	1	1	1
Combination of RCD/CB, C 16A, 30 mA, 4-pin, with auxiliary switch	Unit		1	2	3	4
Power contactor, 3 x 35A	Unit		1	2	3	4
Auxiliary contactor	Unit		1	1	1	1
Switch, 3 settings, 1-pin, 'Manual-0-Automatic'	Unit		1	2	3	4
Indicator 'Operating'	Unit		1	2	3	4
Indicator 'Fault'	Unit		1	1	1	1

When using standard control panels for frost protection additional control devices need to be installed. Factory fitting is possible. Please contact the person responsible at Pentair Thermal Management.

LINE-SENSING CONTROL AND AMBIENT THERMOSTATS (AT-TS-13 AND AT-TS-14)

UNIT LAYOUT

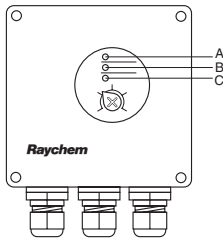

A Green LED	Heating cable on
B Red LED	Sensor break
C Red LED	Sensor short-circuit

TECHNICAL DATA

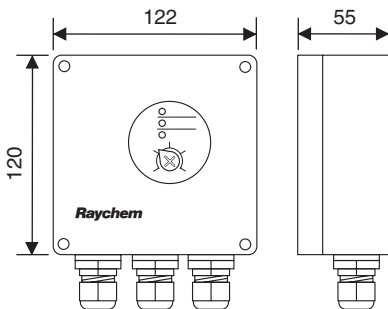

Supply voltage	230 VAC +10% -15% 50/60 Hz
Power consumption	≤ 1.8 VA
Approval	CE
Max. switching current	16 A, 250 VAC
Max. conductor size	2.5 mm ²
Switching differential	0.6 to 1 K
Switching accuracy	AT-TS-13 ±1 K at 5°C (calibration point)
	AT-TS-14 ±2 K at 60°C (calibration point)
Switch type	SPST (normally open)
Adjustable temperature range	AT-TS-13 -5°C to +15°C
	AT-TS-14 0°C to +120°C

HOUSING

Temperature setting	inside
Exposure temperature	-20°C to +50°C
Ingress protection	IP65 according to EN 60529
Entries	1 x M20 for supply cable (Ø 8-13 mm) 1 x M25 for connection heating cable (Ø 11-17 mm) 1 x M16 for sensor
Weight (without sensor)	approx. 440 g
Material	ABS
Lid fixing	nickel-plated quick release screws
Mounting	On wall or on support bracket SB-110/SB-111

TEMPERATUR SENSING (HARD-69)

Type	PTC KTY 83-110
Length sensor cable	3 m
Diameter sensor cable	5.5 mm
Diameter sensor head	6.5 mm
Max. exposure temperature sensor cable	160°C

The sensor cable may be extended up to 100 m using a cable with a cross-section of 1.5 mm². The sensor cable should be shielded if it is laid in cable ducts or in the vicinity of high-voltage cables.

WIRING DIAGRAM FOR THERMOSTAT AT-TS-13 OR AT-TS-14

AT-TS-13/14 DIRECT

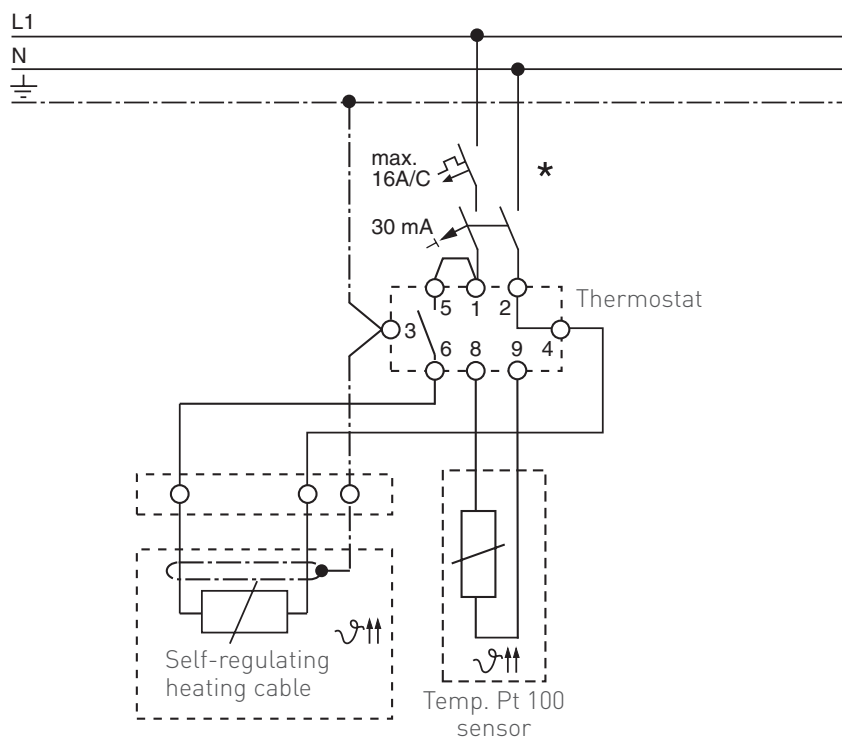
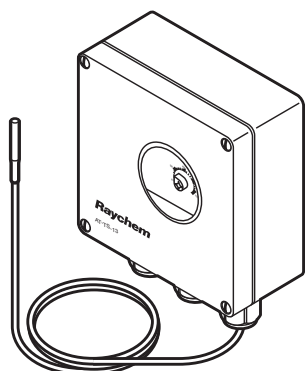

AT-TS-13/14 WITH CONTACTOR

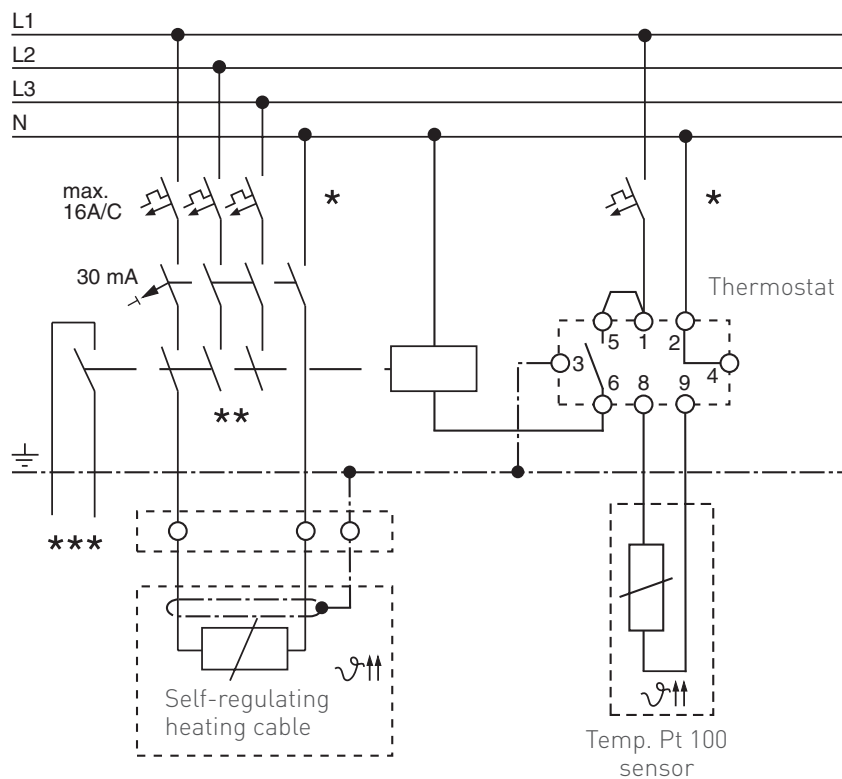

- * Two- or four-pole electrical protection by circuit-breaker may be needed for local circumstances, standards and regulations
- ** Depending on the application, one- or three-pole circuit-breakers or contactors may be used
- *** **Optional:** Potential-free circuit-breaker for connection to the BMS

ENERGY SAVING FROST PROTECTION CONTROLLER

RAYSTAT-ECO-10



DISPLAY

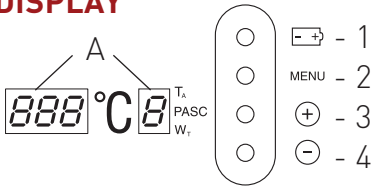

TECHNICAL DATA

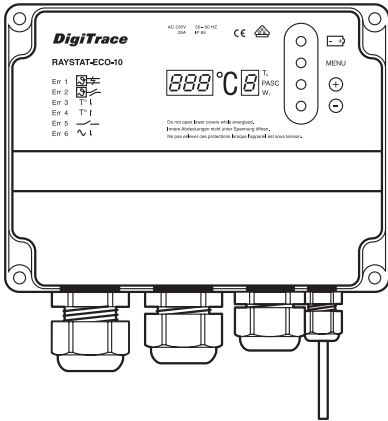

A	LED Display (parameter and error indications)
1	Battery activation
2	Parameter menu selection
3	Increase value
4	Decrease value

Operating Voltage	230 VAC, +10%/-10%, 50/60 Hz
Power Consumption	≤ 14 VA
Main Relay (heating)	I _{max} 25 A, 250 VAC, SPST
Main Terminals	3 x 0.75 mm ² to 4 mm ²
Alarm Relay	I _{max} 2 A, 250 VAC, SPDT, voltfree
Alarm Terminals	(3 + $\frac{1}{2}$) x 0.75 mm ² to 2.5 mm ²
Accuracy	±0.5 K at 5°C

Main parameter settings	
Energy Saving Algorithm	Proportional Ambient Sensing Control (PASC) active below setpoint
Temperature Setpoint	0°C to + 30°C (switch off temperature)
Minimum Expected Ambient	-30°C to 0°C
Temperature	(heating 10 powered)
Heater Operation if Sensor Error	ON (100%) or OFF
Voltage Free Operation	YES or NO

Energy saving with Proportional Ambient Sensing Control (PASC)

Duty cycle (power to heater on) depends on the ambient temperature. For example: If minimum temperature = -15°C and if maintain temperature (set point) = +5°C

ambient t°	% ON	
-15	100	Min. Ambient
-10	75	
-5	50	
0	25	
5	0	Set point

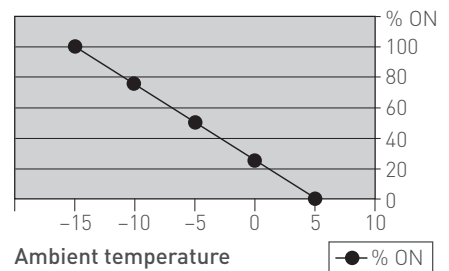

Result: At ambient temperature of -5°C, 50% energy is saved

Diagnosed alarms	
Sensor Errors	Sensor short / Sensor open circuit
Low Temperature	Min. expected ambient temperature reached
Voltage Errors	Low supply voltage / Output voltage / fault
Parameters can be programmed without power supply and parameters are stored in non-volatile memory.	

HOUSING

Size	120 mm x 160 mm x 90 mm
Material	Grey polycarbonate
Exposure Temperature Range	-40°C to +80°C
Ingress Protection	IP 65
Entries	2 x M25, 1 x M20, 1 x M16
Weight	Approx. 800 g
Lid	Transparent with 4 captive screws
Mounting	On wall or on support bracket SB-100/SB-101

TEMPERATURE SENSOR

Sensor Type	3-wire Pt100 according to IEC Class B
Sensor Head	6 mm

Sensor cable can be extended up to 150 m when a cross-section of 3 x 1.5 mm² is used. The sensor cable should be shielded if it is laid in cable ducts or in the vicinity of high-voltage cables.



NORMAL OPERATION

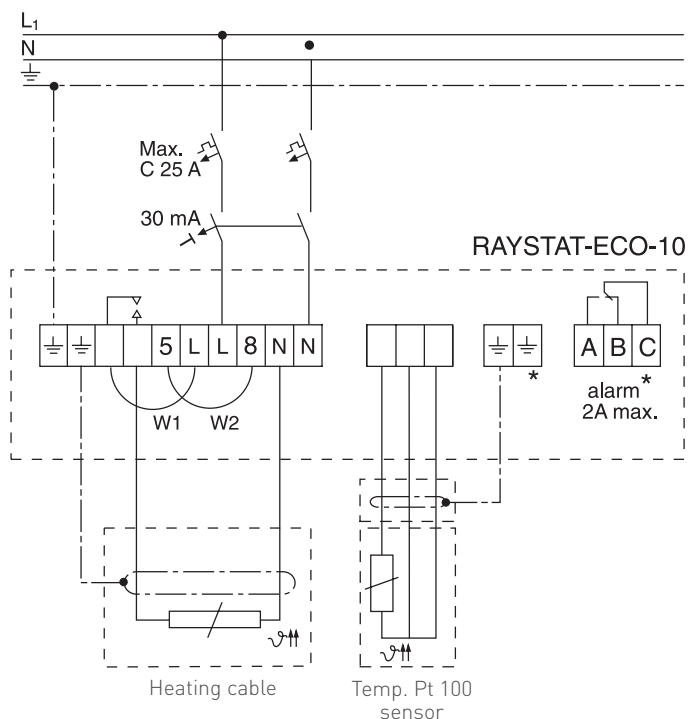
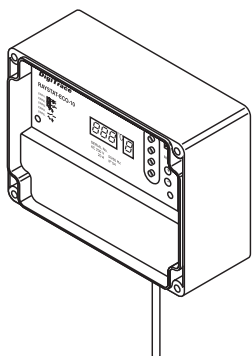

VOLTAGE FREE OPERATION: REMOVE LINKS W1 AND W2

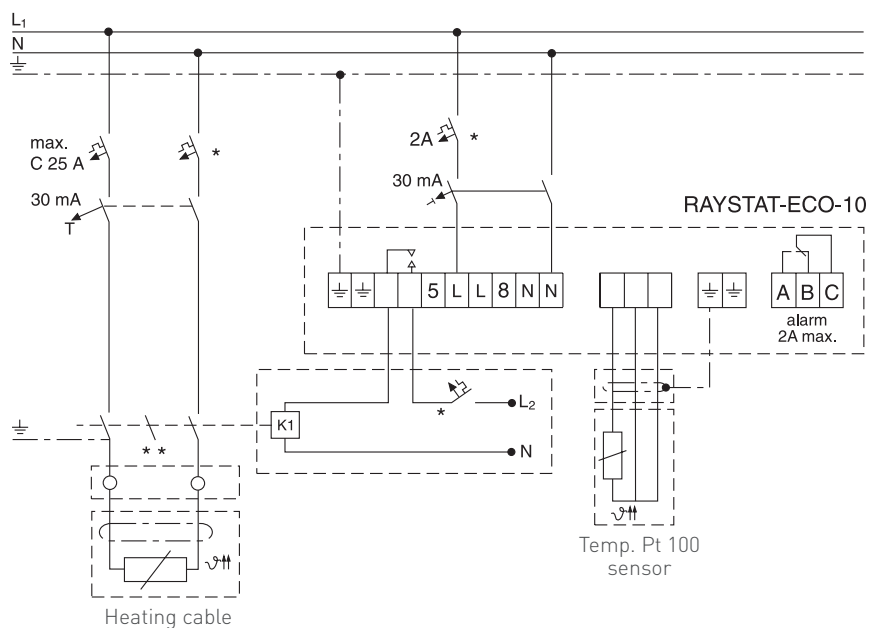

- * Electrical protection by circuit breaker may be needed for local circumstances, standards and regulations.
- ** Depending on the application, one or three-pole circuit breakers or contactors may be used.

LINE-SENSING THERMOSTAT WITH ALARM RELAY RAYSTAT-CONTROL-10

DISPLAY

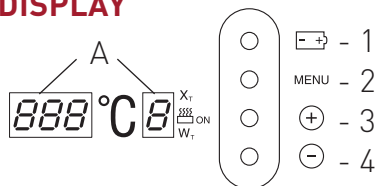

TECHNICAL DATA

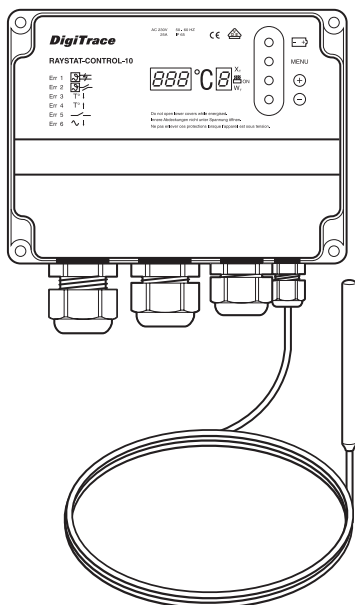

HOUSING

TEMPERATURE SENSOR

A LED Display (parameter and error indications)	
1	Battery activation
2	Parameter menu selection
3	Increase value
4	Decrease value

Operating Voltage	230 VAC, +10%/-10%, 50/60 Hz
Power Consumption	≤ 14 VA
Main Relay (heating)	I _{max} 25 A, 250 VAC, SPST
Main Terminals	3 x 0.75 mm ² to 4 mm ²
Alarm Relay	I _{max} 2 A, 250 VAC, SPDT, voltfree
Alarm Terminals	(3 + $\frac{1}{2}$) x 0.75 mm ² to 2.5 mm ²
Accuracy	±0.5 K at 5°C
Ambient temperature	-40°C to +40°C

Parameter settings	
Temperature Setting	0°C to +150°C
Hysteresis	1 K to 5 K
Low Temperature Alarm	-40°C to +148°C
High Temperature Alarm	+2°C to +150°C or switched OFF
Heater Operation if Sensor Error	ON or OFF
Voltage Free Operation	YES or NO

Diagnosed errors	
Sensor Errors	Sensor short / Sensor open circuit
Temperature Extremes	High temperature / Low temperature
Voltage Errors	Low supply voltage / Output fault

Parameters can be programmed without power supply and parameters are stored in non-volatile memory.

Size	120 mm x 160 mm x 90 mm
Material	Grey polycarbonate
Ingress Protection	IP 65
Entries	2 x M25, 1 x M20, 1 x M16
Weight	Approx. 800 g
Lid	Transparent with 4 captive screws
Mounting	On wall or on support bracket SB-100/SB-101

Sensor Type	3-wire Pt100 according to IEC / Class B
Sensor Head	50 mm x Ø 6 mm
Sensor Cable Length	3 m x Ø 4 mm
Cable Exposure Temperature	-40°C to +150°C (+215°C, 1000 h max.)

Sensor cable can be extended up to 150 m when a cross-section of 3 x 1.5 mm² is used. The sensor cable should be shielded if it is laid in cable ducts or in the vicinity of high-voltage cables.

WIRING DIAGRAM FOR RAYSTAT-CONTROL-10

NORMAL OPERATION

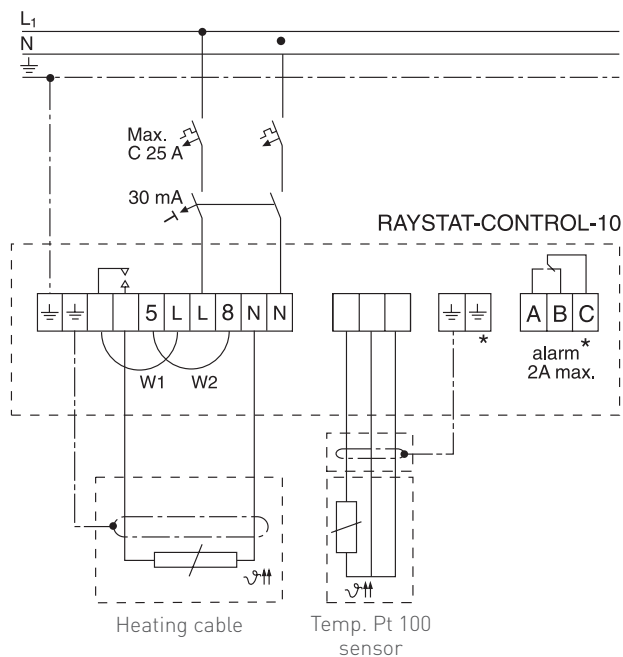
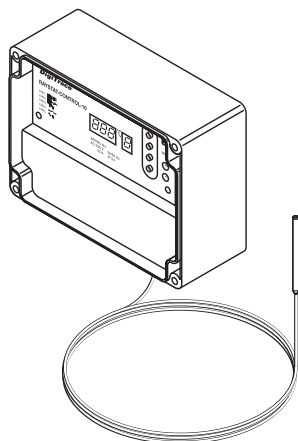

VOLTAGE FREE OPERATION: REMOVE LINKS W1 AND W2

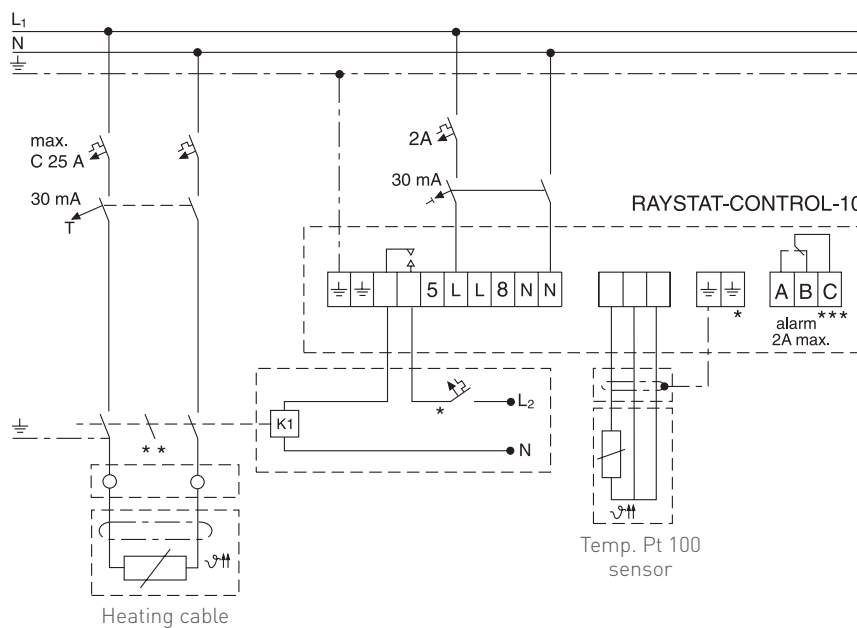

- * Electrical protection by circuit breaker may be needed for local circumstances, standards and regulations
- ** Depending on the application, one or three-pole circuit breakers or contactors may be used
- *** Optional

RAYSTAT-CONTROL-11-DIN LINE-SENSING THERMOSTAT FOR RACK MOUNTING WITH ALARM RELAY

DISPLAY

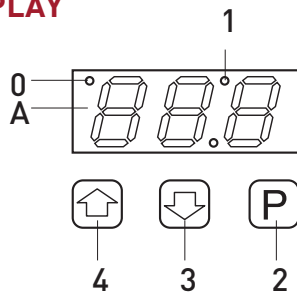

A LED display (parameter and error indications)

0 Control relay ON

1 Alarm relay activated

2 Programming button

3 Reduce value

4 Increase value

TECHNICAL DATA

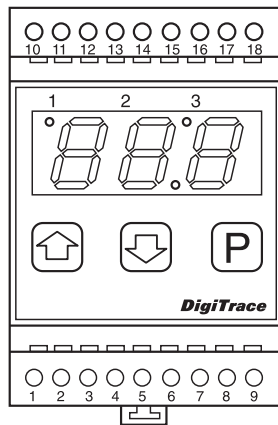

Operating voltage	230 Vac, +10%/-10%, 50/60 Hz
Power consumption	≤5 VA
Control relay (heating)	I _{max} 16 A, AC 250 V, SPST
Connecting terminals	2.5 mm ² screwed
Alarm relay	I _{max} 8 A, AC 250 V, SPDT, voltage-free
Accuracy	±1 K at 0 to 50°C
Operating temperature	-10°C to +55°C
Storage temperature	-20°C to +60°C

Programmable parameter settings		Factory setting
Temperature setting	0°C to +63°C	5°C
Hysteresis	1 K to 5 K	1 K
Low temperature alarm	-15°C to 0°C or „Off“ position.	0°C
Heater operation if sensor error	ON or OFF	ON
Voltage-free operation	YES	

HOUSING

Diagnosed errors	
Sensor error	Sensor short-circuit / Sensor open-circuit / 3-wire sensor missing
Temperature error	Low temperature

All parameters are stored in a non-volatile memory.

Dimensions	51.5 mm x 87.5 mm x 58 mm (W x H x D)
Material	Housing in ABS
Ingress protection	IP 20 (IP 30 installed in switchgear cabinet)
Mounting	DIN 35 mm rack mounting

TEMPERATURE SENSOR

Type	Pt 100 (3-wire technology) as per IEC class B
Sensor element	50 mm x Ø 6 mm stainless steel sheath
Protection rating	IP 68
Sensor cable length	3 m x Ø 5 mm
Ambient temperature	-50°C to 105°C

The sensor can be extended with a 3-wire shielded cable with max. 7.5 Ω per wire (with 3 x 1.5 mm² max. 150 m). The shielding should be earthed in the switchgear cabinet.

WIRING DIAGRAM FOR RAYSTAT-CONTROL-11-DIN

NORMAL OPERATION

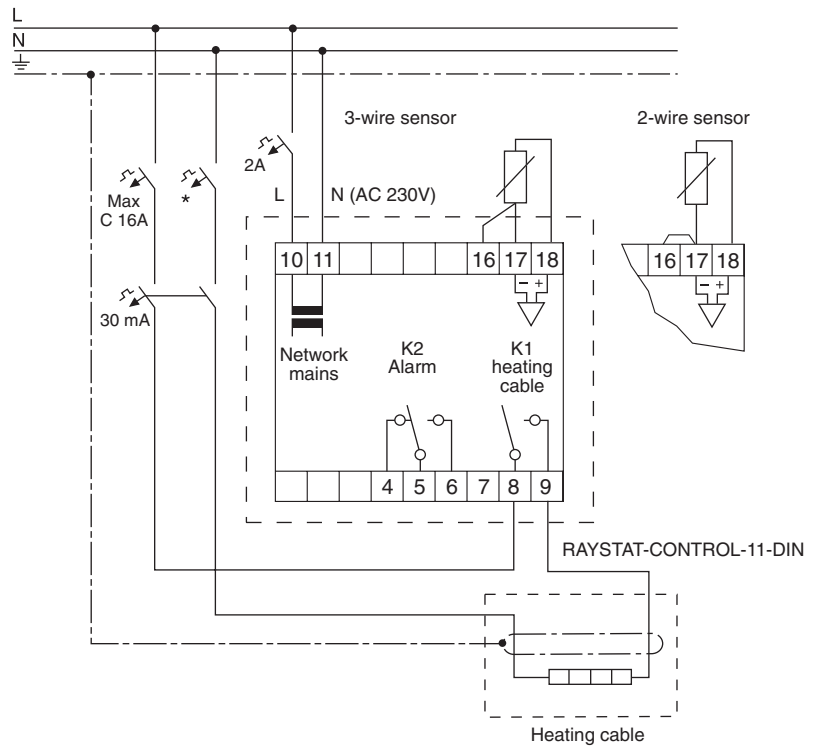
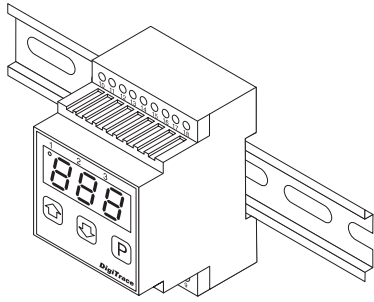

VOLTAGE-FREE OPERATION WITH POWER CONTACTOR

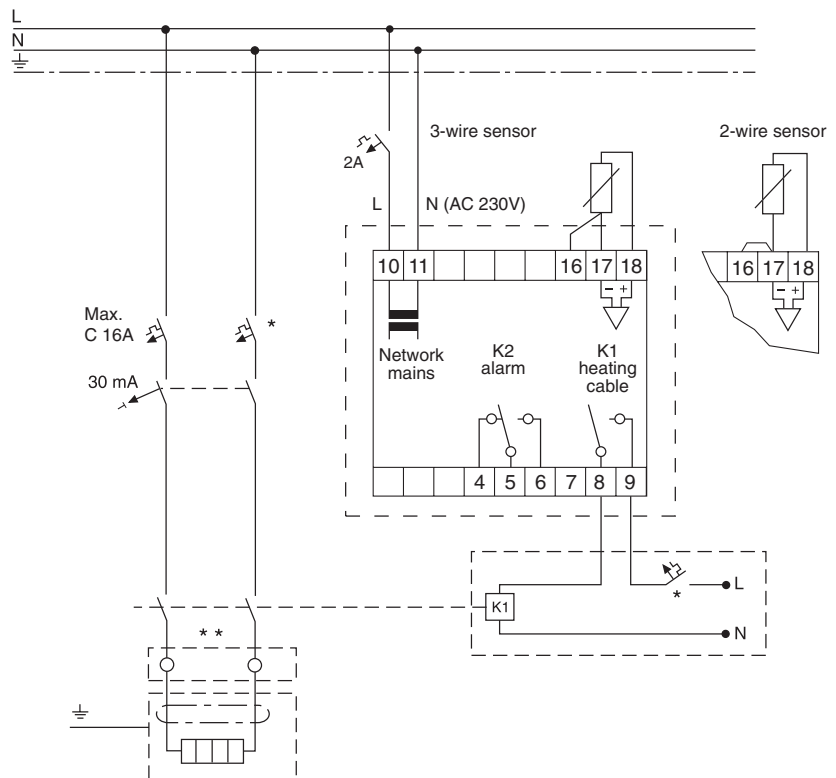

* Regional factors, standards and regulations may require two to four-pole disconnection by circuit breakers/ground fault circuit interrupters.

** Depending on the application, both single and multipole contactors are possible.

FROST PROTECTION FOR PIPES

12 INSTALLATION INSTRUCTIONS FOR FS-A/B/C/C10-2X CABLES

- The heating cable should be installed in a straight line on the pipework.
- Install on dry surfaces
- Minimum installation temperature: -10°C

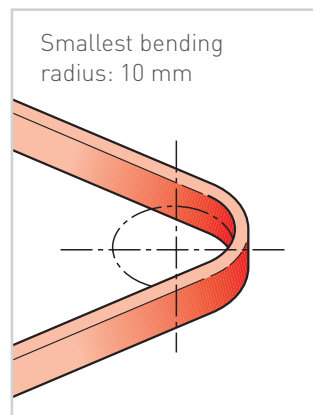
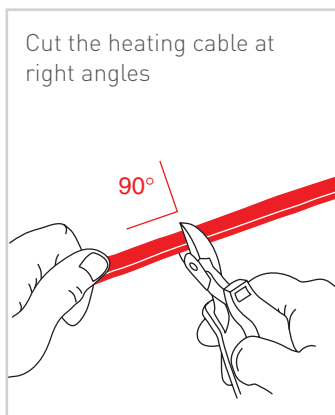
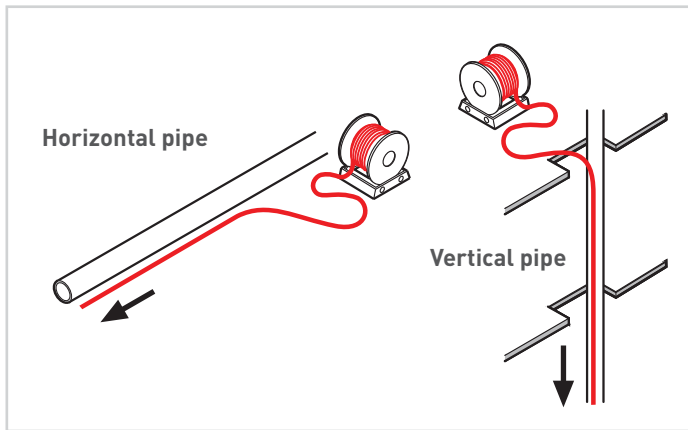

Installation of self-regulating heating cables

- Store in a dry and clean place.
- Temperature range: -40°C to $+60^{\circ}\text{C}$.
- Protect any cable ends with an end seal.

Avoid:

- sharp edges
- high tractive force
- kinking and crushing
- walking or driving over the cable
- moisture at cable interfaces

max. 300 mm

horizontal pipes

ca. 45° ca. 45°

Cable tie KBL-10

For plastic pipes use aluminium adhesive tape ATE-180. Place it over the entire length of the pipe

GT-66 / GS-54 adhesive tape

It is not necessary to spiral the cable around the pipe

Install the heating cables on the outside of the pipe bend

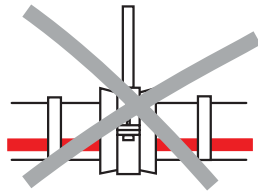
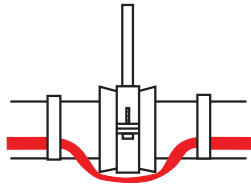

- Run the cable over pipe suspensions
- Do not clamp the cable

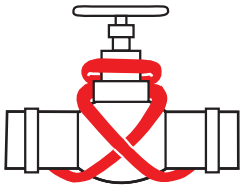
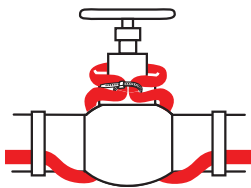

Frost protection at valves:

- Valves up to 2" (DN 50) : install the frost protection heating cables in a straight line
- $\geq 2"$: lay as shown
- Always insulate valves

Wall/Floor transit

The thickness of thermal insulation must be continuous otherwise compensate by adding heating cable.

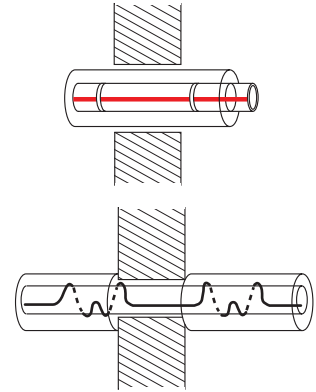

≤ 3 m

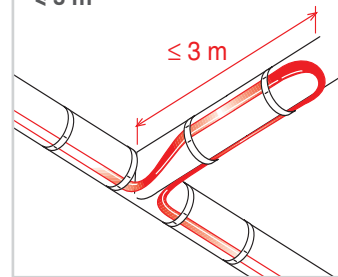

> 3 m + RayClic

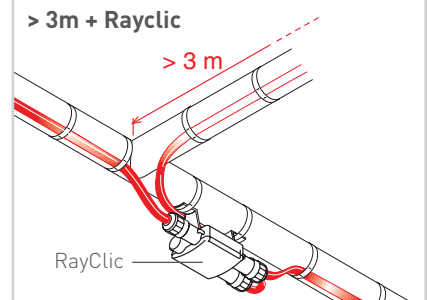

RayClic-T-connection

Electric traced label

IEK-20-M for insertion of heating cable in metal cladding